

Ref #	Name	Part #	Ref #	Name	Part #
1	Powder Coated Steel Sander Tank	SN861T	5	Conduit (not pictured)	SP-11
2	Tank Cap w/ Retaining Lanyard*	S4-53-04	6	Two Hole Grommet	S150-8
3	Powder Coated Steel Valve Guard	SP-02B	7	Fuse Holder w/20A Fuse	SE-11
4	Operating Unit Area (includes gaskets)	see page A4	8	30ft 12 ga. Wire - Black	SE-12
			9	Switch - Truck Style	S40135
			1-6 (x2), 7-9	Set of Series 861 Sanders	S-N861

Representative tank shown. Tank may differ from illustration.

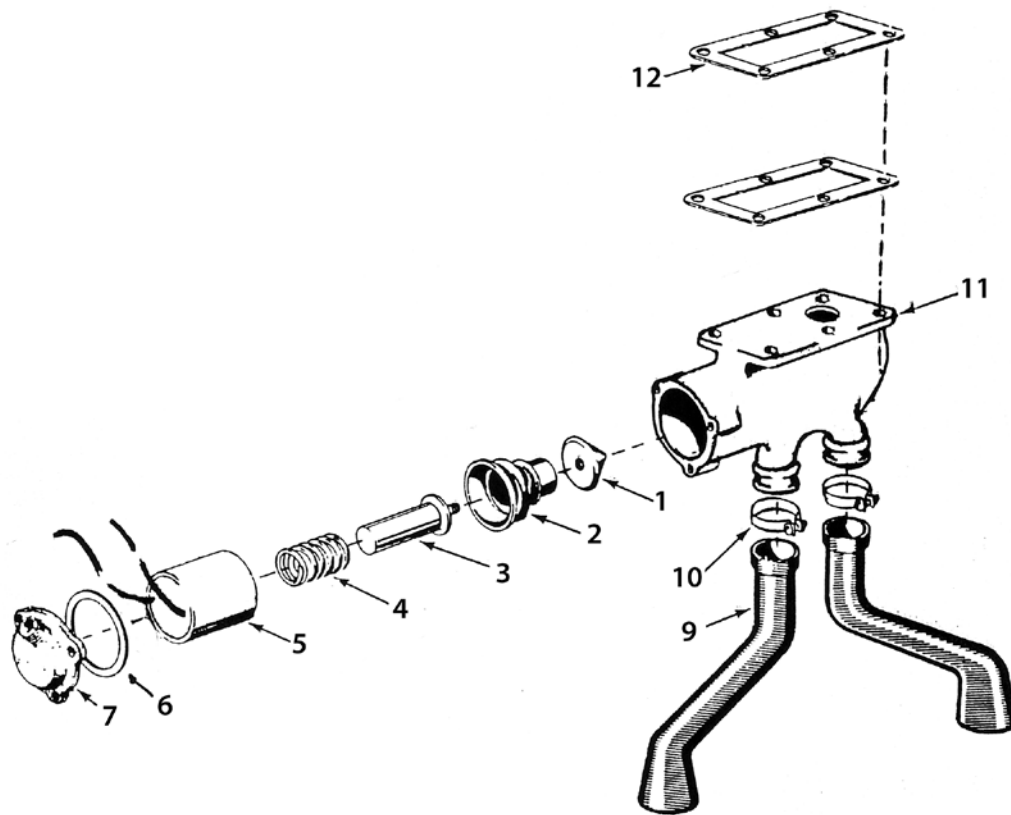

Ref #	Name	Part #	Ref #	Name	Part #
1	Cone Assembly	S15-85	11	Valve Body	S40059
2	Bellows	S161-2	12	Gasket - Valve Body (one installed above SP-02 guard and one installed below)	S16-88
3	Armature	S197-6	1-5	Solenoid & Valve Assy.	S40141
4	Compression Spring	S24-62	1-8,11	Operating Unit	S40084-501
5	Solenoid - 12 V	S40085-501			
6	Solenoid Gasket	S4-41G			
7	Cap - Solenoid Opening	S4-41B			
8	Gasket for Cap (Not Shown)	S16-87			
9	Boot	S124-6			
10	Clamp for Boot	S83-97			

All hardware listed is coarse thread (UNC) and Grade 5 or better unless otherwise noted.