

Ref #	Name	Part #	Ref #	Name	Part #
1	Powder Coated Steel Sander Tank	SN861T	5	Serial Number Decal (Inside Casting)	
2	Tank Cap w/ Retaining Lanyard	S4-53-04	6	Elston Logo Decal	SD-03
3	Powder Coated Steel Valve Guard	SP-02B	7	Grit Decal	SD-04
4	Operating Unit Area (includes gaskets)	see page A6	1-15 (x2)	Set of Series 861 Sanders	S-N861

Add a C to the SN861T and S-N861 for custom colors.

see page A3 for additional parts

Parts List for Traction Sanders

Additional Parts for Sander Assembly

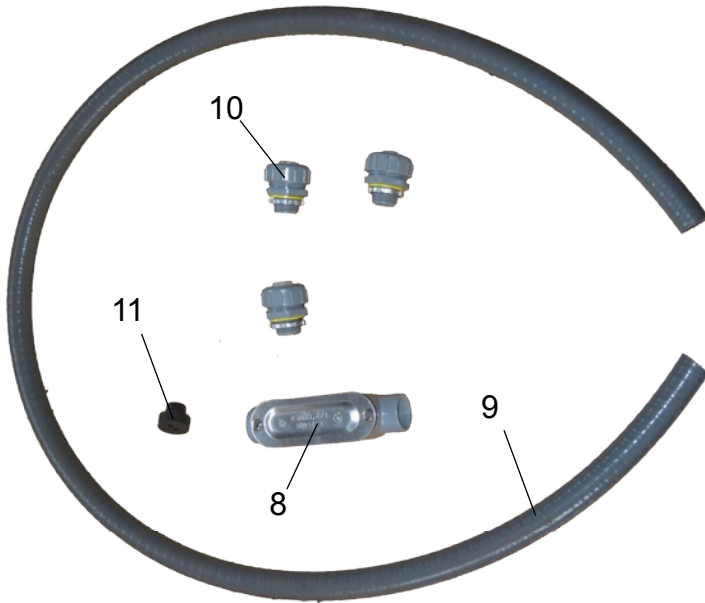

Ref #	Name	Part #
8	Straight Conduit Junction	S150-11
9	6 ft flexible nonmetallic conduit	S150-10
10	Straight thru watertight conduit fittings	S150-14 (x3)
11	Conduit Grommet	S150-8

Ref #	Name	Part #
12	Fuse Holder w/20A Fuse	SE-11
13	30ft 12 ga. Wire - Black	SE-12
14	Switch - Truck Style	S40135

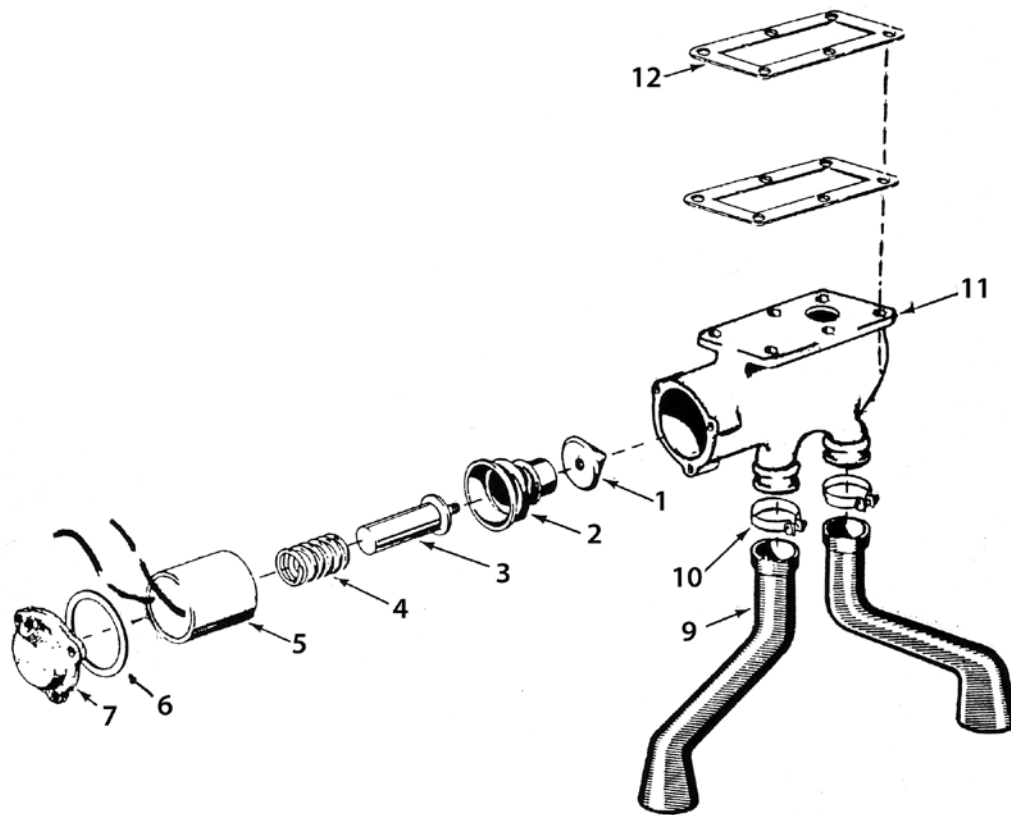

Ref #	Name	Part #	Ref #	Name	Part #
1	Cone Assembly	S15-85	11	Valve Body	S40059
2	Bellows	S161-2	12	Gasket - Valve Body (one installed above SP-02 guard and one installed below)	S16-88
3	Armature	S197-6	1-5	Solenoid & Valve Assy.	S40141
4	Compression Spring	S24-62	1-8,11	Operating Unit	S40084-501
5	Solenoid - 12 V	S40085-501			
6	Solenoid Gasket	S4-41G			
7	Cap - Solenoid Opening	S4-41B			
8	Gasket for Cap (Not Shown)	S16-87			
9	Boot	S124-6			
10	Clamp for Boot	S83-97			

All hardware listed is coarse thread (UNC) and Grade 5 or better unless otherwise noted.